



PCTV/PCMTV/PCTVS15-25

Pressure independent control valves, DN15-DN25 with integrated flow limiter for thermal emitters and differential pressure regulator

PCTV/PCMTV/PCTVS valves are intended for use in fan-coil units, air handling units, chilled beams, etc.

They can be used as constant flow limiters in constant volume systems (without an actuator) or as true PICVs in variable volume systems (with an actuator).

The PCTV/PCMTV/PCTVS valves are temperature control valves with full authority over the entire flow range. This means that each individual terminal receives the flow required even in part load conditions. The PCTV/PCMTV/PCTVS valves do not require any setting ratio calculation or valve authority calculation.

The valves are available in three models, PCMTV that has measuring ports included, PCTV that has measuring port outlets sealed (can be added later if needed) and PCTVS that do not have any measuring ports at all.

The valves have a compact design that allows them to be mounted in small spaces such as fan-coils or narrow supply spaces.

The valves are supplied with a plastic lid which can also be used to close them manually.

Function

The PCTV/PCMTV/PCTVS valves offer remarkable adjustment flexibility. They can be accurately set to a specific flow rate value and allow precise modulating control.

Water flow through a valve varies as a function of the area of passage and the pressure differential across that valve. Thanks to the integrated differential pressure regulator (1) the differential pressure across the valve seats remains constant, meaning that the flow is only dependent of the area of passage. The control valve (2) has equal percentage flow characteristics. It is also possible to set any flow rate value and to maintain it stable. Since flow rate is the only parameter to be considered, choosing the suitable valve is easy and fast.

As the differential pressure variations are instantly corrected, temperature variations and adjustment movements are considerably reduced while the valve and moving devices' lifespans are improved.

Short facts

- Precise hydronic balance gives an increased confort and reduces energy consumption
- Accurate flow control, stable flow rate and constant ΔT through the valves result in a steady and enduring system
- Flow adjustable pre-setting knob offer a remarkable adjustment flexibility
- Easy selection as no authority nor ratio calculations are needed

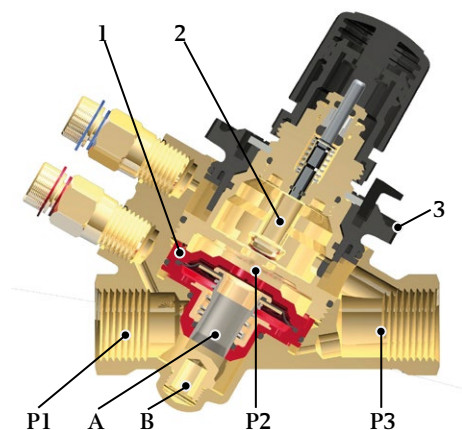

1. differential pressure regulator, 2. regulating valve for flow adjustment, 3. flow presetting knob, A. shutter, B. seat, P1. incoming pressure, P2. pressure below seat, P3. outgoing pressure

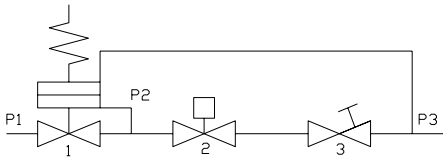

The valves' maximum adjustment matches the maximum flow rate allowed by the pipe size, on the basis of the values established by international standards.

The graduated adjustment knob (3) allows the flow rate to be set without disassembling the actuator. The percentage value, indicated on the scale, matches the maximum flow rate percentage. This value can be changed by turning the adjustment knob until it reaches the selected position (matching the percentage indicated on the scale). A locking mechanism ensures that the valve set values are not changed inadvertently.

Application

The valves are used to control hot and cold water (with max. 50 % glycol) in heating and cooling systems. Typical applications are fan-coil units (FCU), air handling units (AHU), chilled beams (CB), air curtains, heating/cooling interface units and heat exchangers. PCTV/PCMTV/PCTVS valves can also be used as maximum flow limiters (without an actuator).

Start-up pressure

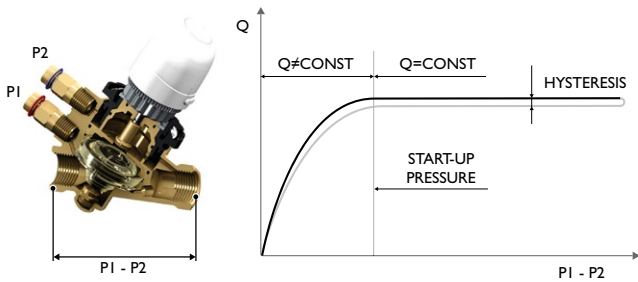

Using a differential pressure gauge to measure the pressure drop the valve absorbs, allows checking whether the valve is in the operating range (and, therefore, whether the flow is constant) by simply verifying that the measured value $P1 - P2$ is higher than the start-up value.

If the ΔP measured value is lower than the start-up value, then the valve works as a fixed orifice valve.

The start-up value varies with the flow setting of the valve.

Each valve has its own max start-up pressure. This is the differential pressure that is needed by the valve in its 100 % flow pre-setting in order to be able to function properly as a PICV. The lower the flow preset setting, the lower the required start-up pressure will be. This is why it is designated as max start-up pressure for the 100 % flow setting.

Before installation

Before filling the terminal unit system with water, make sure the main pipeline has been flushed and most of the dirt and debris have been flushed away. Always comply with local or applicable flushing, however, in order to get the longest life and the best performance from a PICV, Regin does not accept any liability for improper or wrong use of this product.

Always protect the pressure regulator by using strainers upstream of the valve making sure the water quality complies with UNI 8065 standards ($Fe < 0.5 \text{ mg/kg}$ and $Cu < 0.1 \text{ mg/kg}$).

Furthermore, the iron oxide in the water passing through the control valve (PICV) should not exceed 25 mg/kg (25 ppm).

To ensure that the main pipework is cleaned appropriately, flushing bypasses should be used without flushing through the pressure regulator of the PICV, thereby preventing debris that might clog the valve (see figure below).

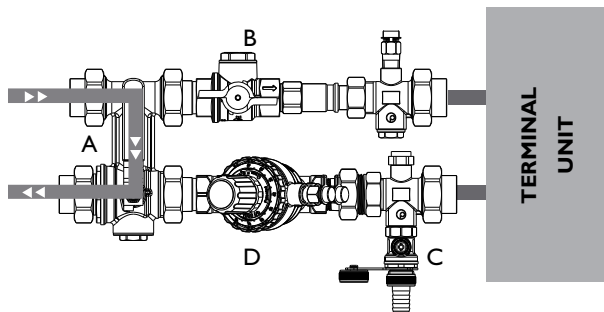

Flushing of main pipe line
A: Bypass mode B: Closed C: Closed D: Open

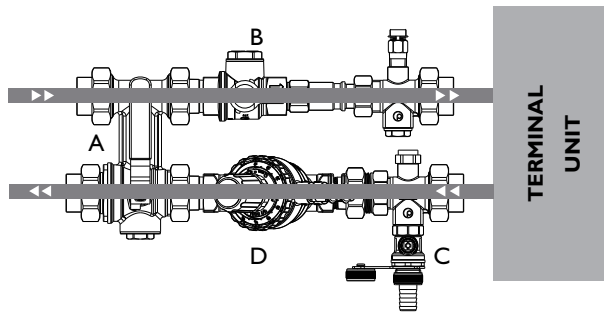

Normal use
A: Normal mode B: Open C: Closed D: Open

Installation

The valve has to be mounted with the arrow pointing in the direction of the flow.



Mounting it in the wrong direction may damage the system and the valve itself.

If flow reversal is possible, a non-return valve should be mounted.

Commissioning

Commissioning is very easy to perform, design flow rates can be modified at any time and at low costs.

Since it is not necessary to commission the valve after its installation, the valve can work immediately after it has been assembled, for example, on the floors where works are already finished.

It is however necessary to be sure that the valve is actually working in the operating range. In order to verify this, just measure the differential pressure across the valve, as shown in the picture.

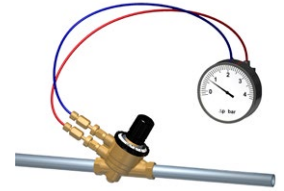

If the measured differential pressure is higher than the start-up pressure, the valve is actually keeping the flow constant at the set value.

In order to adjust the flow rate, just set the selected value using the adjustment knob (see below).

Flow preset

To set the selected flow, follow these steps:



Lift the lock pin to unlock the selector

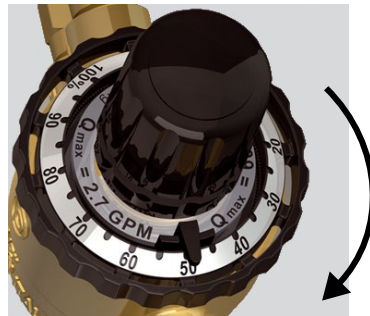

Turn the selector to the target position

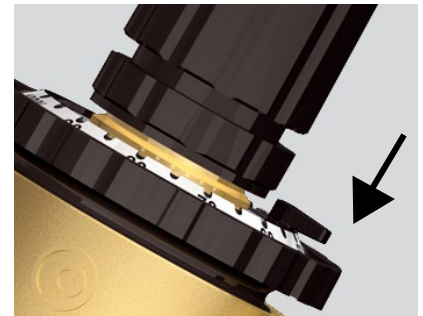

Press the lock pin to lock the selector in the final position

Flow pre-setting table for PCTV and PCMTV DN15 - DN25

Pre-setting %	Flow rate (l/h)				
	F150	F600	F780	F1000	F1500
100	150	600	780	1000	1500
90	135	540	702	900	1350
80	120	480	624	800	1200
70	105	420	546	700	1050
60	90	360	468	600	900
50	75	300	390	500	750
40	60	240	312	400	600
30	45	180	234	300	450
20	-	120	156	200	-
10	-	60	78	100	-

Flow pre-setting table for PCTVS, DN15 - DN20

Pre-setting %	Flow rate (l/h)		
	F150	F600	F900
100	150	600	900
90	135	540	810
80	120	480	720
70	105	420	630
60	90	360	540
50	75	300	450
40	60	240	360
30	45	180	270
20	-	120	180
10	-	60	90

Models

Models without measuring port connectors

Model	Connection	Nominal diameter	Max. start-up pressure	Max. flow rate	ΔP max
PCTVS15-F150	G½"	DN15	20 kPa	150 l/h	600 kPa
PCTVS15-F600	G½"	DN15	25 kPa	600 l/h	600 kPa
PCTVS15-F900	G½"	DN15	30 kPa	900 l/h	600 kPa
PCTVS20-F600	G¾"	DN20	25 kPa	600 l/h	600 kPa
PCTVS20-F900	G¾"	DN20	30 kPa	900 l/h	600 kPa

Models with measuring port connectors but no measuring

Model	Connection	Nominal diameter	Max. start-up pressure	Max. flow rate	ΔP max
PCTV15-F150	G½"	DN15	20 kPa	150 l/h	600 kPa
PCTV15-F600	G½"	DN15	25 kPa	600 l/h	600 kPa
PCTV15-F780	G½"	DN15	35 kPa	780 l/h	600 kPa
PCTV20-F1000	G¾"	DN20	30 kPa	1000 l/h	600 kPa
PCTV20-F1500	G¾"	DN20	35 kPa	1500 l/h	600 kPa
PCTV25-F1500	G1"	DN25	35 kPa	1500 l/h	600 kPa

Models with measuring

Model	Connection	Nominal diameter	Max. start-up pressure	Max. flow rate	ΔP max
PCMTV15-F150	G½"	DN15	20 kPa	150 l/h	600 kPa
PCMTV15-F600	G½"	DN15	25 kPa	600 l/h	600 kPa
PCMTV15-F780	G½"	DN15	35 kPa	780 l/h	600 kPa
PCMTV20-F1000	G¾"	DN20	30 kPa	1000 l/h	600 kPa
PCMTV20-F1500	G¾"	DN20	35 kPa	1500 l/h	600 kPa
PCMTV25-F1500	G1"	DN25	35 kPa	1500 l/h	600 kPa

Technical data

Pressure class	PN25 (25 bar)
Flow characteristics	Equal percentage
Rangeability	50 ~ 100 : 1
Stroke	2.7 mm
Connection	PCTV/PCMTV (DN15-25) and PCTVS (DN15) internal pipe thread according to ISO 228 PCTVS (DN20) external pipe thread according to ISO 228
Media	Hot or cold water, cooling systems (max. 50 % glycol)
Leakage	0.01% of maximum flow, Class IV IEC 60534-4.
Temperature range	-10...120°C
Valve position	Normally open. Valve position is closed when used with a normally closed on/off thermal actuator.

Material

Body	
PCMTV/PCTV	Brass CW602N (CZ121)
PCTVS	Brass CW617N (CZ122)
Plug parabol	Brass CW614N (CZ132)
Stem	Stainless steel
Packing box	O-ring EPDM
Pressure regulator	EPDM, stainless steel and high resistance polymer

Suitable actuators and adapters

Actuators for 2.7 mm stroke

Thermal actuators

Model	Control signal	Supply voltage	Adapter (*)
RTAM100-230	On/Off, NC	230 V AC	VA64
RTAM100-24	On/Off, NC	24 V AC/DC	VA64
RTAM100-24A	0...10 V DC, NC	24 V AC	VA64

Electromechanical actuators

Model	Control signal	Supply voltage	Adapter (*)
RVAPC-24	3-point	24 V AC	VA-7010
RVAPC-230	3-point	230 V AC	VA-7010
RVAPC-24A (**)	0...10 V DC	24 V AC	VA-7010

* Adapters must be ordered separately.

** For valves with 2.7 mm stroke, the actuator needs to be set in 3.2 mm stroke mode

Control characteristics curve

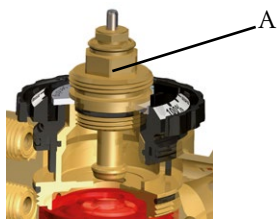

Operating on the position of the control valve's stem A will modify the valve Kv, hence the flow rate.

The relation between Kv and stroke is shown in the graph below.

Typical control valve characteristics curves

$$K_v \% = K_v / K_{v_{max}}$$

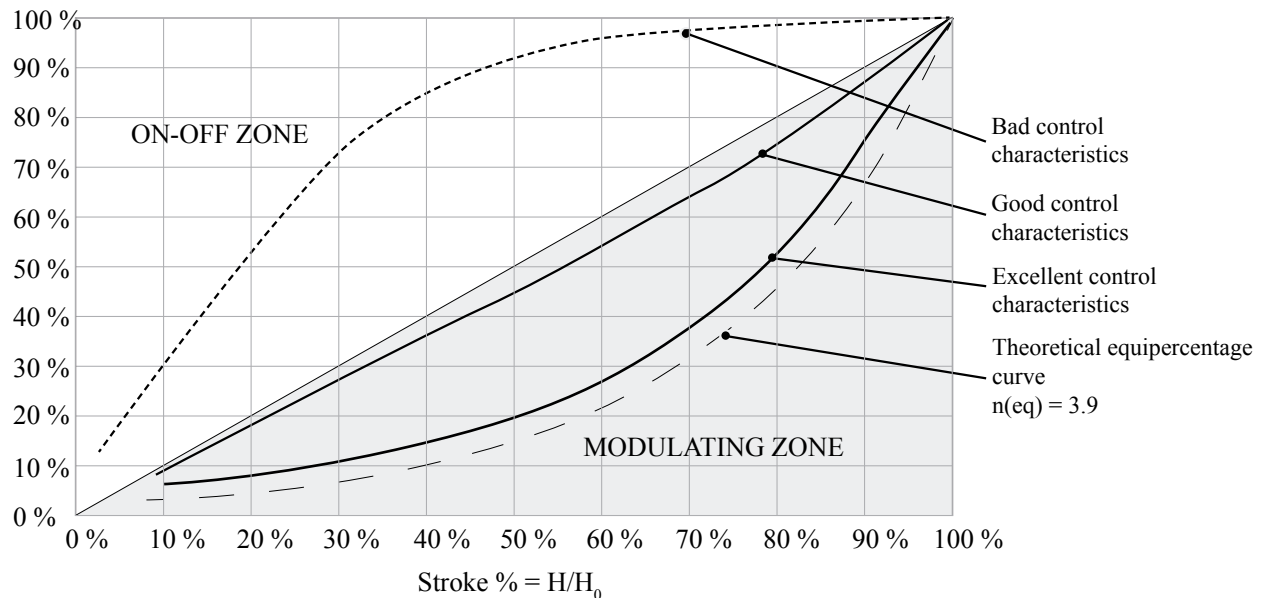

Combining the PCMTV valve characteristics with heat exchanger results in a linear control system.

H = current lift of the control valve; H varies from 0 to H_0

H_0 = maximum lift of the control valve;

K_v = valve flow factor at lift = H

$K_{v_{max}}$ = valve flow factor at lift = H_0

Note: Control curve characteristics may change depending on the valve version.

Dimensions for PCTV/ PCMTV and PCTVS valves, DN15-DN20

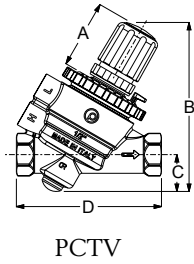

Manual valve

Model	A (mm)	B (mm)	C (mm)	D (mm)
PCTV15-F150	47	115	25	99
PCTV15-F600	47	115	25	99
PCTV15-F780	47	115	25	99
PCTV20-F1000	47	115	25	108
PCTV20-F1500	47	115	25	108

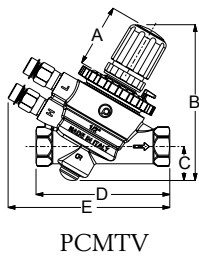

Manual valve

Model	A (mm)	B (mm)	C (mm)	D (mm)	E (mm)
PCMTV15-F150	47	115	25	99	120
PCMTV15-F600	47	115	25	99	120
PCMTV15-F780	47	115	25	99	120
PCMTV20-F1000	47	115	25	108	120
PCMTV20-F1500	47	115	25	108	120

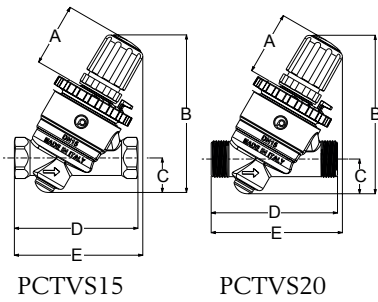

Manual valve

Model	A (mm)	B (mm)	C (mm)	D (mm)	E (mm)
PCTVS15-F150	46	115	25	90	93,5
PCTVS15-F600	46	115	25	90	93.5
PCTVS15-F900	46	115	25	90	93.5
PCTVS20-F600	46	115	25	91.5	95
PCTVS20-F900	46	115	25	91.5	95

Estimated dimensions with actuators for PCTV valves, DN15-DN20

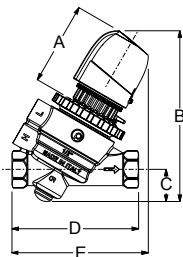

Valve with thermal actuator

Model	A (mm)	B (mm)	C (mm)	D (mm)	E (mm)
PCTV15-F150	65	133	25	99	106
PCTV15-F600	65	133	25	99	106
PCTV15-F780	65	133	25	99	106
PCTV20-F1000	65	133	25	108	106
PCTV20-F1500	65	133	25	108	106

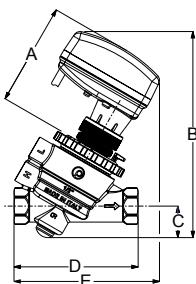

Valve with electromechanical actuator

Model	A (mm)	B (mm)	C (mm)	D (mm)	E (mm)
PCTV15-F150	82	164	25	99	116
PCTV15-F600	82	164	25	99	116
PCTV15-F780	82	164	25	99	116
PCTV20-F1000	82	164	25	108	116
PCTV20-F1500	82	164	25	108	116

Estimated dimensions with actuators for PCMTV valves, DN15-DN20

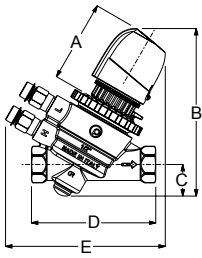

Valve with thermal actuator

Model	A (mm)	B (mm)	C (mm)	D (mm)	E (mm)
PCMTV15-F150	65	133	25	99	127
PCMTV15-F600	65	133	25	99	127
PCMTV15-F780	65	133	25	99	127
PCMTV20-F1000	65	133	25	108	127
PCMTV20-F1500	65	133	25	108	127

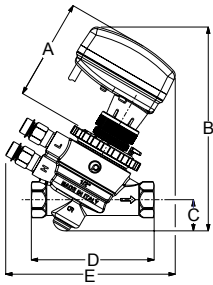

Valve with electromechanical actuator

Model	A (mm)	B (mm)	C (mm)	D (mm)	E (mm)
PCMTV15-F150	82	164	25	99	137
PCMTV15-F600	82	164	25	99	137
PCMTV15-F780	82	164	25	99	137
PCMTV20-F1000	82	164	25	108	137
PCMTV20-F1500	82	164	25	108	137

Estimated dimensions with actuators for PCTVS valves, DN15-DN20

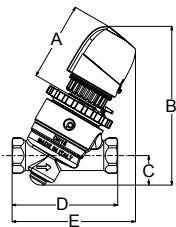

PCTVS15

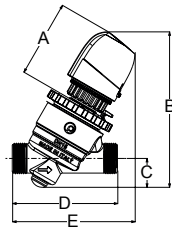

PCTVS20

Valve with thermal actuator

Model	A (mm)	B (mm)	C (mm)	D (mm)	E (mm)
PCTVS15-F150	67	135	25	90	105
PCTVS15-F600	67	135	25	90	105
PCTVS15-F900	67	135	25	90	105
PCTVS20-F600	67	135	25	91.5	106.5
PCTVS20-F900	67	135	25	91.5	106.5

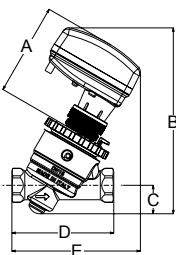

PCTVS15

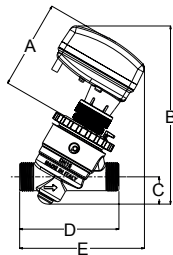

PCTVS20

Valve with electromechanical actuator

Model	A (mm)	B (mm)	C (mm)	D (mm)	E (mm)
PCTVS15-F150	82	164	25	90	115
PCTVS15-F600	82	164	25	90	115
PCTVS15-F900	82	164	25	90	115
PCTVS20-F600	82	164	25	91.5	115
PCTVS20-F900	82	164	25	91.5	115

Dimensions for PCTV and PCMTV valves, DN25

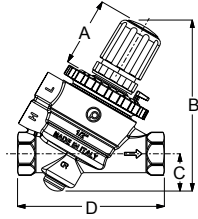

Manual valve, PCTV

Model	A (mm)	B (mm)	C (mm)	D (mm)
PCTV25-F1500	47	115	25	130

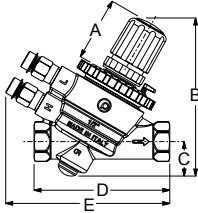

Manual valve, PCMTV

Model	A (mm)	B (mm)	C (mm)	D (mm)	E (mm)
PCMTV25-F1500	47	115	25	130	134

Estimated dimensions with actuators for PCTV and PCMTV valves, DN25

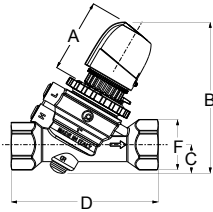

PCTV valve with thermal actuator

Model	A (mm)	B (mm)	C (mm)	D (mm)	F (mm)
PCTV25-F1500	65	133	25	130	44.5

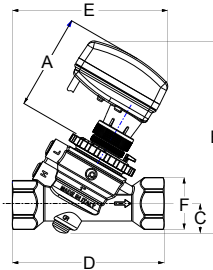

PCTV valve with electromechanical actuator

Model	A (mm)	B (mm)	C (mm)	D (mm)	E (mm)	F (mm)
PCTV25-F1500	82	164	25	130	134	44.5

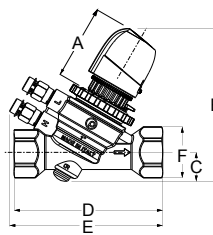

PCMTV valve with thermal actuator

Model	A (mm)	B (mm)	C (mm)	D (mm)	E (mm)	F (mm)
PCMTV25-F1500	65	133	25	130	134	44.5

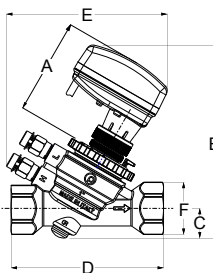

PCMTV valve with electromechanical actuator

Model	A (mm)	B (mm)	C (mm)	D (mm)	E (mm)	F (mm)
PCMTV25-F1500	82	164	25	130	138	44.5