

# HTRT10A(-D)

Humidity and temperature transmitters



*A range of room transmitters for measuring humidity and temperature in indoor environments.*

- ✓ Analogue output signal
- ✓ Temperature sensors, 0...10 V DC referring to 0...50°C and PT1000 class DIN B
- ✓ Output signal humidity, 0...10 V DC referring to 0...100 % RH
- ✓ Humidity, 10...90 % RH
- ✓ Temperature, 0...50°C
- ✓ Good long-term stability

## Function

Transmitters intended for wall mounting in HVAC systems.

## Temperature sensors

The unit has built-in 0...10 V and PT1000 temperature sensors, working range 0...50°C.

**Note!** The PT1000 sensor is not compensated for internal warm-up. The passive temperature output must be calibrated with a controller.

## Relative humidity

The transmitters have a capacitive thin-film element that provides a 0...10 V signal proportional to the relative humidity in the range 0...100 % RH.

The measuring element responds quickly to changes in humidity and has excellent long-term stability.

## Supply voltage

The transmitter uses a supply voltage of 24 V AC  $\pm$ 10 % or 15...35 V DC. It automatically detects and adapts to the supply voltage connected.

## Display (-D models)

Display models have an LCD display showing temperature and humidity in an alternating series.

## Technical data

<b>Output signal</b>	Analogue
<b>Supply voltage (UV)</b>	24 V AC $\pm 10\%$ or 15...35 V DC
<b>Power consumption</b>	< 1 W
<b>Transformer power</b>	2 VA
<b>Electrical connection</b>	Screw terminals max. 1.5 mm <sup>2</sup> (AWG 16)
<b>Storage temperature</b>	-25...+60°C
<b>Operating temperature</b>	0...50°C
<b>Ambient humidity</b>	10...90 % RH non-condensing
<b>Protection class</b>	IP30
<b>Dimensions (WxHxD)</b>	85 x 100 x 30.5 mm
<b>Colour</b>	Signal white RAL 9003

## Technical data, humidity sensor

<b>Humidity sensor</b>	Capacitive
<b>Analogue output 0...100 % RH</b>	0...10 V, IL $\leq 1$ mA
<b>Working range</b>	10...90 % RH
<b>Accuracy at 20°C</b>	$\pm 3\%$ RH

## Technical data, temperature sensor I...10 V

<b>Analogue output 0...50°C</b>	0...10 V DC, IL $\leq 1$ mA
<b>Working range</b>	0...50°C
<b>Accuracy at 20°C</b>	$\pm 0.4^\circ\text{C}$

## Technical data, temperature sensor PT1000

<b>Output signal temperature</b>	PT1000 class DIN B
<b>Working range</b>	0...50°C
<b>Accuracy at 20°C</b>	$\pm 0.3^\circ\text{C}$

## Models

<b>Article</b>	<b>Description</b>
HTRT10A	Humidity and temperature transmitter
HTRT10A-D	Humidity and temperature transmitter with display

## CE

This product carries the CE mark. For more information, see [www.regincontrols.com](http://www.regincontrols.com).

## Dimensions

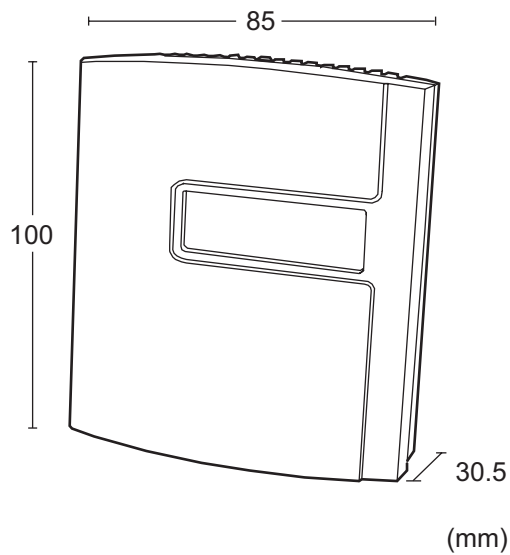

## Wiring

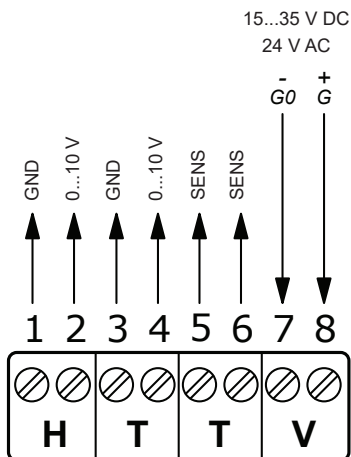

GND and G0 are internally connected.

## Product documentation

The product documentation can be downloaded from [www.regincontrols.com](http://www.regincontrols.com)