

INDUSTRIAL PRESSURE TRANSMITTER

Swiss based Trafag is a leading international supplier of high quality sensors and monitoring instruments for measurement of pressure and temperature. The economical pressure transmitter ECT 8472 is based on the tried and true ECT line of transmitters. The wide media temperature range from -25 to 125°C in combination with a comprehensive set of features and options makes the ECT 8472 pressure transmitter a versatile solution suitable for most industrial applications.



Applications

- Machine tools
- Hydraulics
- Water treatment

Features

- Excellent media compatibility
- Relative or absolute pressure measurement
- Titanium version optional
- Frontal membrane optional

Technical Data			
Measuring principle	Thick-film-on-ceramic	Accuracy @ 25°C typ.	± 0.5 % FS typ.
Measuring range	0 ... 1 to 0 ... 400 bar 0 ... 15 to 0 ... 5000 psi	Media temperature	-25°C ... +125°C 400 bar/5000 psi: -10°C ... +125°C
Output signal	4 ... 20 mA, 0 ... 5 VDC, 1 ... 6 VDC, 0 ... 10 VDC, 0.5 ... 4.5 VDC ratiom.	Ambient temperature	max. -25°C ... + 125°C (UL-rated ambient temperature: -20°C ... +80°C) 400 bar/5000 psi: -10°C ... +125°C details see section Electrical Connection
NLH @ 25°C (BSL) typ.	± 0.2 % FS typ.		

07/2024

Data sheet H72324ar

Subject to change

Ordering information/type code

				8472 . XX	XX	XX	XX	XX	XX	
Measuring range ¹⁾	Pressure measurement range [bar]	Over pressure [bar]	Burst pressure [bar]							
	0 ... 1.0	2	3	71	0 ... 15	30	40	G1		
	0 ... 1.6	3.2	4.8	73	0 ... 20	40	60	G3		
	0 ... 2.5	5	7.5	75	0 ... 30	60	90	G5		
	0 ... 4	8	12	76	0 ... 50	100	150	G6		
	0 ... 6	12	15	77	0 ... 100	200	250	G7		
	0 ... 10	20	25	78	0 ... 150	300	375	G8		
	0 ... 16	32	40	79	0 ... 200	400	600	GA		
	0 ... 25	50	75	80	0 ... 250	500	625	G9		
	0 ... 40	80	100	81	0 ... 400	800	1200	H0		
	0 ... 60	120	180	82	0 ... 500	1000	1250	H1		
	0 ... 100 ⁴⁾	200	300	83	0 ... 1000	2000	3000	H2		
	0 ... 160 ⁴⁾	320	480	85	0 ... 1500 ⁴⁾	3000	4500	H3		
	0 ... 250 ⁴⁾	500	750	74	0 ... 2000 ⁴⁾	4000	6000	H5		
	0 ... 400 ^{2) 4)}	800	1000	84	0 ... 3000 ⁴⁾	6000	9000	G4		
					0 ... 5000 ^{2) 4)}	10000	12500	H4		
	Option 5P:	Fivefold overpressure								
	0 ... 2.5	12.5	18	55						
	0 ... 4	20	30	56						
	0 ... 6	30	48	57						
	0 ... 10	50	75	58						
	0 ... 16	80	120	59						
0 ... 25	125	180	60							
0 ... 40	200	300	61							
0 ... 60	300	480	62							
Sensor	Relative pressure, Material pressure connection and housing: 1.4305 (AISI303)		57	Absolute pressure, Material pressure connection and housing: 1.4305 (AISI303) ³⁾			87			
	Relative pressure, Material pressure connection and housing: 1.4404/1.4435 (AISI316L) ⁴⁾		59	Absolute pressure, Material pressure connection and housing: 1.4404/1.4435 (AISI316L) ^{3) 4)}			89			
	Relative pressure, Material pressure connection and housing: 1.4462 (AISI318LN) ⁴⁾		52	Absolute pressure, Material pressure connection and housing: 1.4462 (AISI318LN) ^{3) 4)}			82			
	Relative pressure, titanium grade 5 ⁴⁾		53	Absolute pressure, titanium grade 5 ^{3) 4)}			83			
Pressure connection	G1/4" female						10			
	G1/4" male						17			
	G1/2" male DIN3852-A ⁴⁾						21			
	G1/2" male DIN3852-E ⁴⁾						41			
	G1/2" male DIN3852-E, with inner cone ^{4) 13) 15)}						59			
	1/4" NPT male, ANSI B1.20.1 ⁴⁾						30			
	1/8" NPT male, ANSI B1.20.1 ¹¹⁾						43			
	7/16"-20UNF-2A male, SAE J1926-3 (Light Duty) ^{4) 7)}						42			
	7/16"-20UNF male, DIN3866 ³⁾						18			
	7/16"-20UNF female, SAE J512 with valve opener ³⁾						24			
	7/16"-20UNF female, SAE J512 without valve opener ³⁾						44			
	9/16"-18UNF-2A male, SAE J1926-3 (Light Duty), seal: accessory 61 ^{4) 7) 14)}						61			
	R1/4" male, DIN3858						19			
Electrical connection	Male electrical connector EN 175301-803-A (DIN 43650-A), Mat. PA						05			
	Male electrical connector M12x1, 5-pole, Mat. PBT						35			
	Male electrical connector Packard Metri Pack, Mat. PBT ¹⁶⁾						51			
	Cable PUR (Screwed cable gland PA 6-3), -20°C ... +70°C ^{5) 6)}						24			
	Cable PVC (Screwed cable gland PA 6-3), -5°C ... +60°C ^{5) 6) 9)}						22			
	Cable Raychem (Screwed cable gland PA 6-3), -20°C ... +100°C ^{3) 6) 9)}						08			

Output signal	Signal output	Load resistance	I (supply)	U (supply)		
	4 ... 20 mA	(U _{supply} -9 V) / 20 mA	(= signal output)	9 ... 30 VDC	19	
	0 ... 5 VDC	≥ 2.5 kΩ	≤ 20 mA	10 ... 30 VDC	14	
	1 ... 6 VDC	≥ 5.0 kΩ	≤ 20 mA	10 ... 30 VDC	16	
	0 ... 10 VDC	≥ 5.0 kΩ	≤ 20 mA	15 ... 30 VDC	17	
	0.5 ... 4.5 VDC ratiometric	≥ 5.0 kΩ	≤ 20 mA	5 VDC ± 0.25 VDC ratiom.	23	
Accessories	Seal FKM (-20°C ... +125°C)				61	
	Seal CR ≤ 100 bar (-25°C ... +100°C) ⁸⁾				62	
	Seal EPDM (-25°C ... +125°C)				63	
	Pressure peak damping element ø 1.0 mm, material 1.4305 ¹⁰⁾				40	
	Pressure peak damping element ø 0.4 mm, material 1.4305 (sensors 57, 87) resp. 1.4404 (sensors 52, 53, 59, 82, 83, 89) ¹⁰⁾				44	
	Female electrical plug EN 175301-803-A (DIN43650-A)/NBR, -40°C ... +90°C, for cable diameter 4 ... 9 mm, flammability standard UL94-V0					46
	Female electrical plug EN 175301-803-A (DIN 43650-A)/silicone, -40°C ... +125°C, for cable diameter 4 ... 9 mm, flammability standard UL94-V0					56
	Female electrical plug EN 175301-803-A (DIN43650-A)/NBR, -40°C ... +90°C, for cable diameter 4 ... 9.5 mm, flammability standard UL94-V2					58
	Female electrical plug M12x1, 5-pole					33
	Special electrical connection: Pin 1 +, Pin 2 - (only for output signal 4 ... 20 mA and male electrical connector EN175301-803-A / DIN43650-A)					92
	Special electrical connection: Pin 1 Out, Pin 2 -, Pin 3 + (only for output 14, 16, 17, 23 and male electrical connector EN175301-803-A / DIN43650-A)					98
	Special electrical connection: Pin 1 +, Pin 2 -, Pin 3 Out (only for output signals 14, 16, 17, 23 and male electrical connector EN 175301-803-A / DIN 43650-A)					97
	Special electrical connection: Pin 1 +, Pin 3 -, Pin 5 Ground (only for output signal 4 ... 20 mA and male electrical connector 35, M12x1, 5-pole)					94
	Special electrical connection: Pin 1 +, Pin 3 -, Pin 4 Ground (only for output signals 19 and male electrical connector 35, M12x1, 5-pole)					G9
	Special electrical connection: Pin 1 +, Pin 2 -, Pin 5 Ground (only for output signals 19 and male electrical connector 35, M12x1, 5-pole)					H1
	Special electrical connection: Pin 1 +, Pin 3 - (only for output 4 ... 20 mA and male electrical connector Packard Metri Pack 3-poles)					E4
	Special electrical connection: Pin 1 +, Pin 3 Out, Pin 2 -, Pin 5 Ground (only for output signals 14, 16, 17, 23 and male electrical connector 35, M12x1, 5-pole)					E8
	Special electrical connection: Pin 1 +, Pin 2 Out, Pin 3 - (only for output signals 14, 16, 17, 23 and male electrical connector Packard Metri Pack 3-poles)					99
	Cable length 1.5 m					1M
	Cable length 3.0 m					3M
	Cable length 5.0 m					5M
	Housing nut for electrical connection EN175301-803-A (DIN43650-A) secured with Loctite (max. 85°C)					L9
	Multiple packaging ¹²⁾					VM
UL-listed version					UL	

¹⁾ Extended overpressure as well as customized pressure ranges upon request, see table "Customised measuring ranges"

²⁾ Media -10°C ... +125°C

³⁾ max. 40 bar

⁴⁾ Upon request

⁵⁾ Cable length see accessories (max. length 50 m, in 5-meter sections)

⁶⁾ IP68-rated protection: Immersion depth max. 3 m, Media +10°C ... +35°C

⁷⁾ Measuring range max. 350 bar according to SAE J1926-3 (Light Duty)

⁸⁾ Only for pressure connections 10, 30, 43, 18, 24, 44, 19

⁹⁾ Pressure ranges > 16 bar (Pressure ranges ≤ 16 bar upon request)

¹⁰⁾ Not for pressure connections 10, 18, 24, 44

¹¹⁾ Only for sensors 59 and 89 and electrical connections 35, 51 (others on request)

¹²⁾ The order quantity must be a multiple of 50, only for electrical connections 05 and 35

¹³⁾ Only for sensors 52 and 82

¹⁴⁾ Only for sensors 59 and 89

¹⁵⁾ max. 60 bar / overpressure 120 bar

¹⁶⁾ Do not use for new designs as this option will be phased out soon. Only limited quantities available.



Vacuum measuring ranges: Measuring ranges below 0 bar (e.g. -1 bar ... 0 bar) are available as special pressure ranges.



For absolute pressure sensors, the measuring range must include the point 1000 mbar (absolute).



Reversed calibration: A reversed calibration is also possible for measuring ranges below 0 bar, with the signals 4 ... 20 mA (code 19), 1 ... 6 VDC (code 16) and 0 ... 10 VDC (code 17). The signal zero point is at 0 bar, the signal end point at -1 bar. Additional configurations on request.

Customised measuring ranges					
Min. pressure ¹⁾	Max. pressure ²⁾	Min. span	Max. span	Overpressure	Code
-1	1	≥ 0.5	≤ 1.2	2	21
-1	2	≥ 0.8	< 2	3.2	22
-1	4	≥ 2	≤ 4.5	8	24
-1	6	> 4.5	≤ 7	12	25
-1	10	> 7	≤ 11	20	26
-1	16	> 11	≤ 17	32	27
-1	25	> 17	≤ 26	50	28
-1	40	> 26	≤ 41	80	29
-1	60	> 41	≤ 61	120	30
-1	100	> 61	≤ 101	200	31
-1	160	> 101	≤ 161	320	35
-1	250	> 161	≤ 251	500	32
-1	400	> 251	≤ 401	800	34

All pressures in bar

1) Minimum pressure= lowest zero point, start of measuring range (relative)

2) Maximum pressure= highest pressure, end of measuring range (relative)

Standard products (extra short lead time)					
Product No.	Type Code	Pressure range [bar]	Over pressure max. [bar]	Signal output	Supply [VDC]
ECT1.0A	8472 71 5717 05 0000 0000 19 58 61	0 ... 1	3.2	4 ... 20 mA	9 ... 30
ECT1.6A	8472 73 5717 05 0000 0000 19 58 61	0 ... 1.6	3.2	4 ... 20 mA	9 ... 30
ECT2.5A	8472 75 5717 05 0000 0000 19 58 61	0 ... 2.5	5	4 ... 20 mA	9 ... 30
ECT4.0A	8472 76 5717 05 0000 0000 19 58 61	0 ... 4	8	4 ... 20 mA	9 ... 30
ECT6.0A	8472 77 5717 05 0000 0000 19 58 61	0 ... 6	12	4 ... 20 mA	9 ... 30
ECT10.0A	8472 78 5717 05 0000 0000 19 58 61	0 ... 10	20	4 ... 20 mA	9 ... 30
ECT16.0A	8472 79 5717 05 0000 0000 19 58 61	0 ... 16	32	4 ... 20 mA	9 ... 30
ECT25.0A	8472 80 5717 05 0000 0000 19 58 61	0 ... 25	50	4 ... 20 mA	9 ... 30
ECT40.0A	8472 81 5717 05 0000 0000 19 58 61	0 ... 40	80	4 ... 20 mA	9 ... 30
ECT60.0A	8472 82 5717 05 0000 0000 19 58 61	0 ... 60	120	4 ... 20 mA	9 ... 30
ECT1.0V	8472 71 5717 05 0000 0000 17 58 61	0 ... 1	3.2	0 ... 10 VDC	15 ... 30
ECT1.6V	8472 73 5717 05 0000 0000 17 58 61	0 ... 1.6	3.2	0 ... 10 VDC	15 ... 30
ECT2.5V	8472 75 5717 05 0000 0000 17 58 61	0 ... 2.5	5	0 ... 10 VDC	15 ... 30
ECT4.0V	8472 76 5717 05 0000 0000 17 58 61	0 ... 4	8	0 ... 10 VDC	15 ... 30
ECT6.0V	8472 77 5717 05 0000 0000 17 58 61	0 ... 6	12	0 ... 10 VDC	15 ... 30
ECT10.0V	8472 78 5717 05 0000 0000 17 58 61	0 ... 10	20	0 ... 10 VDC	15 ... 30
ECT16.0V	8472 79 5717 05 0000 0000 17 58 61	0 ... 16	32	0 ... 10 VDC	15 ... 30
ECT25.0V	8472 80 5717 05 0000 0000 17 58 61	0 ... 25	50	0 ... 10 VDC	15 ... 30
ECT40.0V	8472 81 5717 05 0000 0000 17 58 61	0 ... 40	80	0 ... 10 VDC	15 ... 30
ECT60.0V	8472 82 5717 05 0000 0000 17 58 61	0 ... 60	120	0 ... 10 VDC	15 ... 30

Specifications		
Accuracy	TEB typ. @ -25 ... +85°C	± 3.0 % FS typ.
	Accuracy @ 25°C typ.	± 0.5 % FS typ.
	NLH @ 25°C (BSL) typ.	± 0.2 % FS typ.
	TC zero point and span typ.	± 0.03 % FS/K typ.
	Long term stability 1 year typ.	± 0.3 % FS typ.
Electrical data	Output / supply voltage	4 ... 20 mA: 24 (9 ... 30) VDC 0 ... 5 VDC: 24 (10 ... 30) VDC 1 ... 6 VDC: 24 (10 ... 30) VDC 0 ... 10 VDC: 24 (15 ... 30) VDC 0.5 ... 4.5 VDC ratiom.
	Rise time	Typ. 1 ms / 10 ... 90 % nominal pressure
	Power-on delay time	Max. 1.5 s
	Inverse-polarity protection, short-circuit strength @ 25°C during 5 min.	4 ... 20 mA: to $U_s = 30$ VDC 0 ... 10 VDC, 0 ... 5 VDC, 1 ... 6 VDC: to $U_s = 30$ VDC 0.5 ... 4.5 VDC ratiometric: to $U_s = 5.25$ VDC
Environmental conditions	Media temperature	-25°C ... +125°C 400 bar/5000 psi: -10°C ... +125°C
	Ambient temperature	max. -25°C ... +125°C (UL-rated ambient temperature: -20°C ... +80°C) 400 bar/5000 psi: -10°C ... +125°C details see section Electrical Connection
	Protection	IP65, IP67, IP68 details see section Electrical Connection
	Humidity	Max. 95 % relative
	Vibration	15 g RMS (20...2000 Hz) (EN 60068-2-64) 15 g Sinus (10...2000 Hz) (EN 60068-2-6)
	Shock	50 g / 11 ms (EN 60068-2-27)
EMC protection	Emission	EN/IEC 61000-6-3
	Immunity	EN/IEC 61000-6-2
Mechanical data	Sensor (wetted parts)	Ceramic, Al ₂ O ₃ (96 %)
	Pressure connection (wetted parts)	57/87: 1.4305 (AISI303) 59/89: 1.4404/1.4435 (AISI316L) 52/82: 1.4462 (AISI318LN) 53/83: Titanium Grade 5
	Housing	57/87: 1.4305 (AISI303) 59/89: 1.4404/1.4435 (AISI316L) 52/82: 1.4462 (AISI318LN) 53/83: Titanium Grade 5
	Sealing	FKM 70 Sh, CR, EPDM
	Male electrical connector	See ordering information
	Weight	~ 110 g
	Mounting torque	15 ... 20 Nm

Measuring accuracy 0.5 %

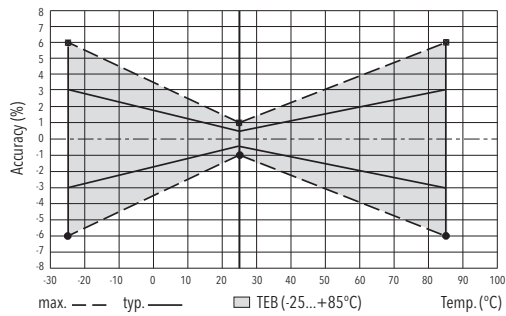

Electrical connection

		Protection / electrical connection										
		IP65*)	IP67*)	IP67*)	IP68 max. 3m	IP68 max. 3 m	IP68 max. 3 m					
		Industrial standard EN175301-803A **)	M12x1 **) 5-pole	Packard Metri Pack **) 3-pole	Cable **)	Cable **)	Cable **)					
		05	35	51	22	24	08					
Ambient temperature		-25°C ... +125°C		-25°C ... +125°C		-5°C ... +60°C	-20°C ... +70°C	-20°C ... +125°C				
UL-rated ambient temperature		-20°C ... +80°C		-20°C ... +80°C		-5°C ... +60°C	-20°C ... +70°C	-20°C ... +80°C				
Output signal	<p>8472.xx.xxxx.xx.19</p>	Standard	92	Standard	94	G9	H1		E4	white brown yellow	white brown yellow	red black green
	<p>8472.xx.xxxx.xx.14/16/17/23</p>	Standard	98	97		E8			99	white green brown yellow	white green brown yellow	red white black green

- *1) Provided female electrical plug is mounted according to instructions
- **1) Ventilation via male electric plug/cable end
- ***1) Only cable versions or female electrical plug with shield connection

Additional information		
Documents	Data sheet	www.trafag.com/H72324
	Instructions	www.trafag.com/H73324
	Flyer	www.trafag.com/H70662

Dimensions

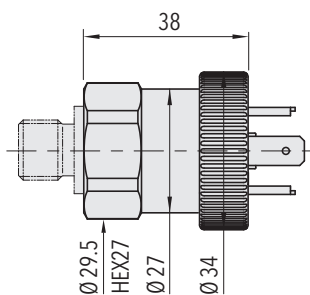

8472.XX.XXXX.05.XX.XX

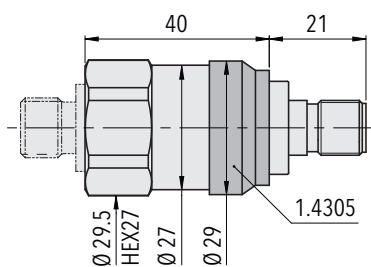

8472.XX.XXXX.35.XX.XX

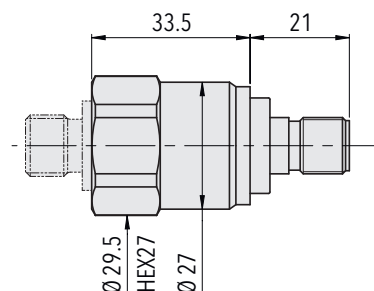

8472.XX.X717.35.XX.XX

8472.XX.X917.35.XX.XX

8472.XX.X942.35.XX.XX

8472.XX.X943.35.XX.XX

8472.XX.X952.35.XX.XX

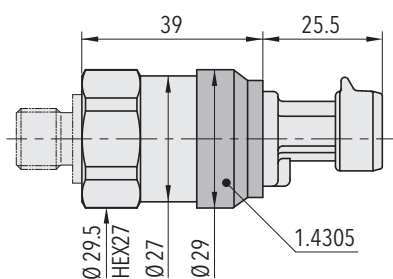

8472.XX.XXXX.51.XX.XX

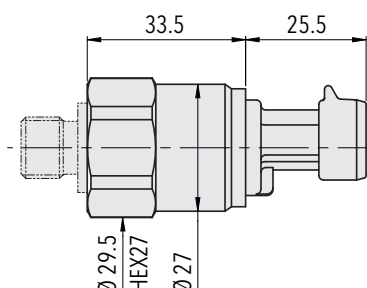

8472.XX.X717.51.XX.XX

8472.XX.X917.51.XX.XX

8472.XX.X942.51.XX.XX

8472.XX.X943.51.XX.XX

8472.XX.X952.51.XX.XX

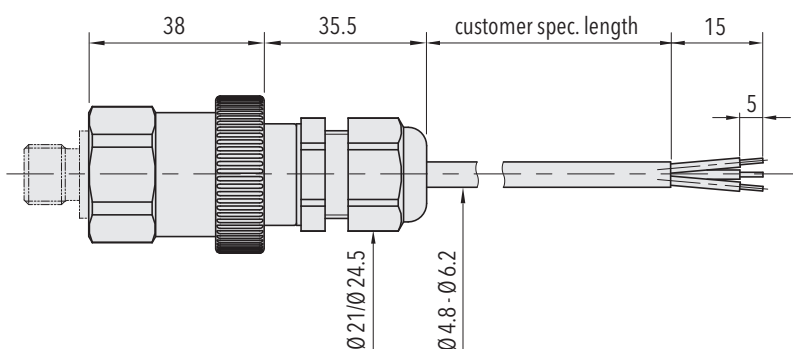

8472.XX.XXXX.22/24/08.XX.XX

Dimensions

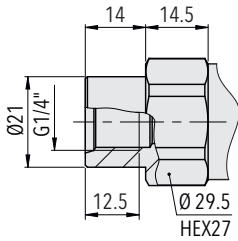

8472.XX.XX10.XX.XX.XX

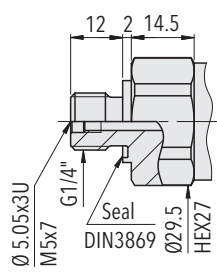

8472.XX.XX17.XX.XX.XX

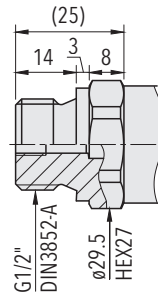

8472.XX.XX21.XX.XX.XX

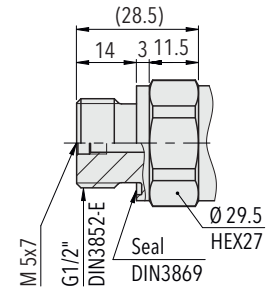

8472.XX.XX41.XX.XX.XX

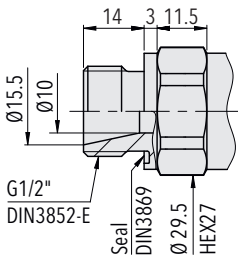

8472.XX.XX59.XX.XX.XX

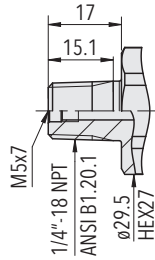

8472.XX.XX30.XX.XX.XX

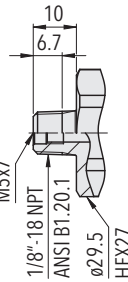

8472.XX.X943.XX.XX.XX

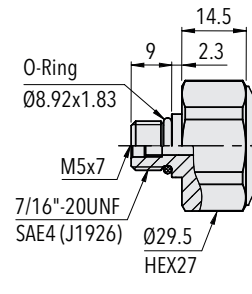

8472.XX.XX42.XX.XX.XX

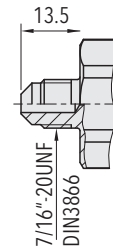

8472.XX.XX18.XX.XX.XX

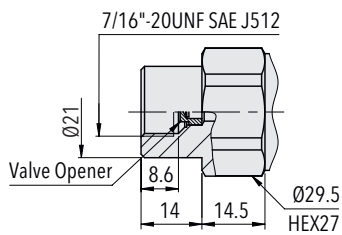

8472.XX.XX24.XX.XX.XX

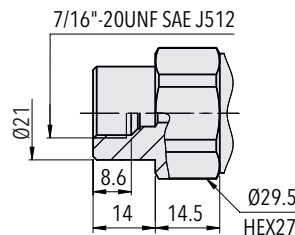

8472.XX.XX44.XX.XX.XX

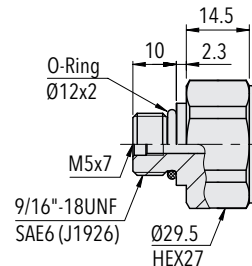

8472.XX.XX61.XX.XX.XX

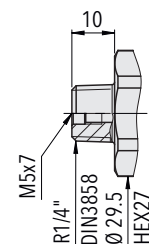

8472.XX.XX19.XX.XX.XX

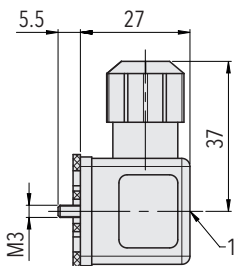

1) Tightening torque 50...60 Ncm

8472.XX.XXXX.XX.XX.46/56

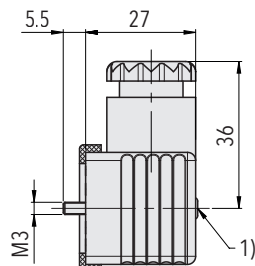

1) Tightening torque 50...60 Ncm

8472.XX.XXXX.XX.XX.58

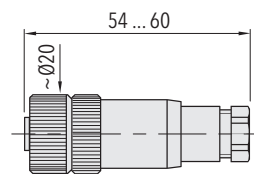

8472.XX.XXXX.XX.XX.33